

ZXA16 Center Pivot

IP67

ACCENT & LANDSCAPE | ZX16 Adapt Series | 2.25"
5 - 10W (500 - 950lm) | 12V | HK LED



ZXA16 Center Pivot Accent Light with G Style Angled Glare Shield Hood: ZXA16-0C1SG-ABL



ZXA16 Center Pivot Accent Light with F Style Flush Lens Hood: ZXA16-0C1SF-ABR

FEATURES

- Our newest and most versatile Center Pivot directional low voltage (12V) LED Accent Light, features the Adapt Optic for precise light aiming in architectural outdoor and landscape lighting environments.
- Adapt Optic enables easy beam angle adjustment from 14° to 70° with a quick hood slide, locking securely in place with a set screw for precise and reliable positioning.
- 5W, 7W, 10W integrated HK LED delivers 500, 775, and 950 lumens. 2700-4000K CCT.
- Wet Location Listed, IP67 Standard.
- Machined and anodized aircraft grade aluminum (6061-T6). Powder coated to create a highly durable, marine and natatorium grade finish. Also available in solid brass or stainless steel.
- 240° vertical and 360° horizontal adjustment via locking swivel stem design.
- Two weeping hood styles available, integrated Angled Glare Shield or Flush Lens. With less than 1% field light, the Adapt Optic provides superior glare control in both hood options.
- Every fixture tested end of line for water tightness and light quality.
- Readymade eligible configurations ship in 2 to 4 weeks, complete with selected accessories installed.

SPECIFICATIONS

Materials

Machined from solid billet 6061-T6 corrosion resistant aluminum with 304 stainless steel hardware. Available in 304 or 316 stainless steel or 360 brass upon request.

Finish

Aluminum materials are first anodized and then powder coated for a robust, marine and natatorium grade finish. Stainless steel and brass models are provided with brushed surface.

Hood Styles

Two weeping hood styles available. The G Style includes an integrated Angled Glare Shield, while the F Style has a Flush Lens, without a glare shield. Both options provide exceptional glare control. (See page 4 for details).

Voltage

12V AC/DC. Requires remote step down transformer.

Wattage

5, 7 or 10W HK LED delivering 500 to 950 lumens.

Light Engine

Innovative HK LED Light module operates like a lamp and can be easily changed in the field. CRI 90 Standard. Available in CRI 80 upon request. Standard CCT options are 2700K, 3000K, 3500K, 4000K.

Dimming

MLV or ELV Phase Control dimming.

Optics

The Adapt Optic allows precise beam angle adjustment from a very narrow 14° spotlight to an extra wide 70° flood, locking securely with the hood screw. It maintains less than 1% field light levels, minimizing glare even with the sleek Flush Lens Hood.

Mounting

Mounts using 1/2"-14 NPS male fitting compatible with all HK Lighting mounting accessories. (See page 4 for details).

Listings

UL Listed for Wet Location (UL1838), IP67 Standard. RoHS Compliant.

ORDERING GUIDE

EXAMPLE: ZXA16-0C1SG-ABL-012V07W-27A-MHCS-06

MODEL	OPTIONS				MATERIAL / FINISH		POWER		LIGHT		
ZXA16	OC1						012V				
ZX16 Adapt Series 2.25" Accent Light Integrated HK LED	TYPE	STYLE	HOOD		ABL Aluminum Black		VOLTAGE	WATTAGE		CCCT	
	OC1 Low Voltage, Center Pivot Accent	S Standard F Finned	G Adjustable Hood: Integrated Angled Glare Shield	F Adjustable Hood: Flush Lens	ABR Aluminum Bronze		012V 12V AC	05W 5 Watts (500lm)	27 2700K	A Adjustable Beam (14° - 70°)	
					AWH Aluminum White			07W 7 Watts (775lm)	30 3000K		
					AAC Aluminum Anodized Clear ¹			10W 10 Watts (950lm)	35 3500K		
					NBR Natural Brass ¹				40 4000K		
					NCU Natural Copper ¹						
					NSS Natural Stainless Steel ¹						

 Readymade eligible configurations ship in 2 to 4 weeks
¹ Consult factory for specialty finish quoting and lead times

OPTIONAL INSTALLED ACCESSORIES

MOUNTING (Most common listed, see Page 4 for additional options)

GROUND MOUNT	
MHCS-06	6" PVC Single Prong Spike (12V)
MHCS-12	12" PVC Single Prong Spike (12V)
MH02-06-BRZ	6" Stainless Steel 3-Prong Spike (12V) Bronze
MH02-12-BRZ	12" Stainless Steel 3-Prong Spike (12V) Bronze
JB-1	Brass In-ground Junction Box
CANOPY MOUNT	
CM1-XXX	3.75" Square Canopy Plate
CM3-XXX	4.75" Square Canopy Plate
CM5-XXX	5" Round Canopy Plate
CM5-2-XXX	5" Round Canopy Plate - Double
SURFACE MOUNT	
CMLJ-XXX	2.7" Round Surface Box
CB4.0-XXX	4" Round Surface Box
CB5.5-XXX	5.5" Round Surface Box
TREE MOUNT	
TM125-ABR	Aluminum Tree Mount Box (12V)
TM125-TS-ABR	Stainless Steel Strap for TM125
EXTENSIONS	
EX-RD-12-XXX	12" Round Extension
EX-RD-24-XXX	24" Round Extension

- Consult Accessory Spec Sheet for desired option code.
- XXX represents color option.
- Readymade options available in ABL and ABR only unless noted by the part code above.

OUTDOOR MAGNETIC TRANSFORMERS (120V input/12VAC Output)

TRANSFORMERS (Go to [Accessories](#) for detailed specification)

EXAMPLE: TXM-300-OTR-SS

MODEL		WATTAGE (VA)						PRIMARY VOLTAGE (VAC)	
TXM	Stainless steel, wet location outdoor magnetic transformer Multitap 12VAC Output MLV Dimming	300						OTR-SS (120V Only)	
TXS	Stainless steel, wet location outdoor magnetic transformer Multitap 12VAC Output MLV Dimming	150	300	600				SS (120V Only)	
TXM	Compact, damp location magnetic transformer 12VAC Output MLV Dimming	20	40	60	100	150	300	120	277
IGT	In ground outdoor magnetic transformer 12VAC Output MLV Dimming	50 (120V Only)			100	300	600	120	277
TXE	In-fixture or near mounted electronic transformer 12VAC Output ELV Dimming Enclosure by others	60						120	277

PRODUCT DRAWINGS

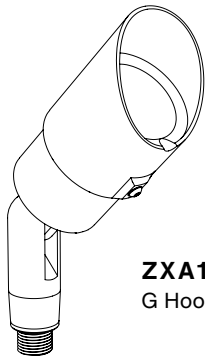

ZXA16-0C1SG
G Hood

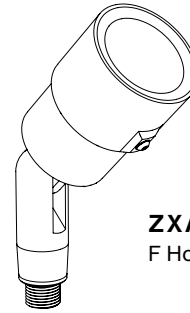

ZXA16-0C1SF
F Hood

ZXA16-0C1SG

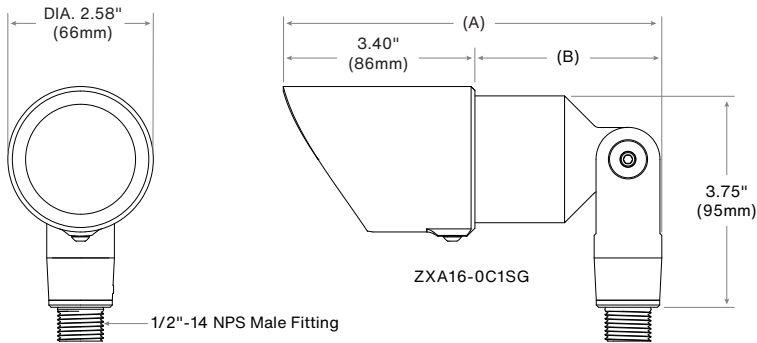

Beam Angle (FWHM)	Dimension (A)	Dimension (B)
70	6 3/4" / 171mm	3 5/16" / 84mm
50	6 15/16" / 176mm	3 1/2" / 89mm
35	7 1/8" / 181mm	3 11/16" / 94mm
25	7 5/16" / 186mm	3 15/16" / 100mm
14	7 13/16" / 198mm	4 3/8" / 111mm

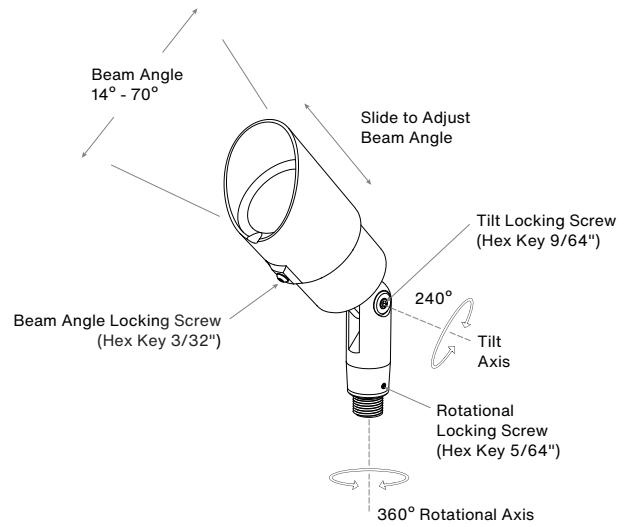

ZXA16-0C1SF

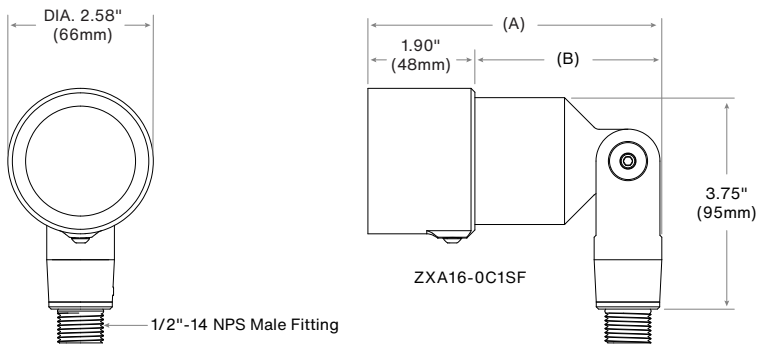

Beam Angle (FWHM)	Dimension (A)	Dimension (B)
70	5 3/16" / 132mm	3 5/16" / 84mm
50	5 7/16" / 137mm	3 1/2" / 89mm
35	5 5/8" / 142mm	3 11/16" / 94mm
25	5 13/16" / 148mm	3 15/16" / 100mm
14	6 1/4" / 159mm	4 3/8" / 111mm

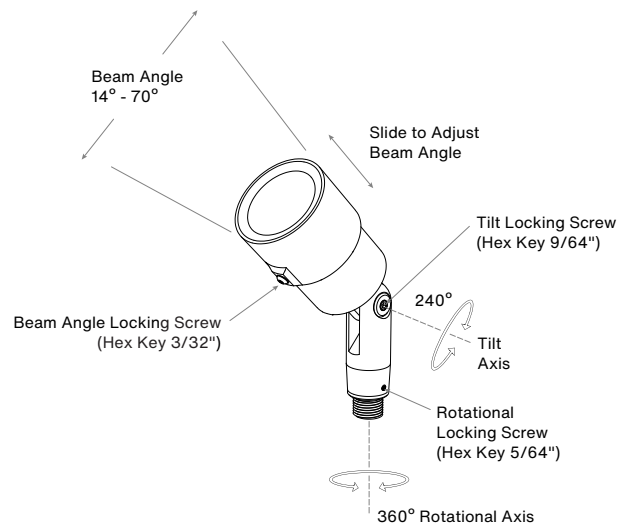

OPTIONS & ACCESSORIES

HOOD OPTIONS

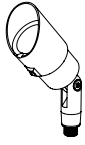

G HOOD

Weeping hood style includes an integrated Angled Glare Shield. Locking screw sets the beam angle.

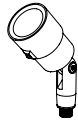

F HOOD

Weeping style hood with a Flush Lens. This style prevents any liquid or debris from settling on the lens making it ideal for heavy debris fall or limited maintenance applications. Locking screw sets the beam angle.

MOUNTING ACCESSORIES

Canopy Mount:

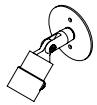

Fixture On CM5



CM1



CM3



CM5



CM5-2



CM2

Surface Mount Box:

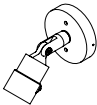

Fixture On CB5.1



CMLJ



CB4.0



CB5.5



CB3.5



CB4.0-SQ



CB5.1



CB5.1-2



CB5.5-2



CB5.5-2K



CB5.5-2-2K

Ground Mount:



Fixture On MH02

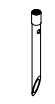

MHCS

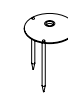

MH02-06

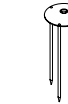

MH02-12



JB-1

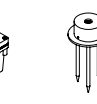

MH02-T-06

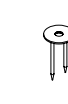

MH05



MH02-T-12



MHVL-06-12



MHVL-12-24

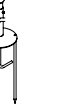

MH01

Tree Mount:

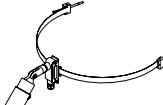

Fixture On TM120-TS

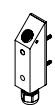

TM125

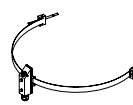

TM125-TS

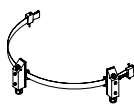

TM125-TS-2

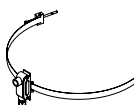

TM120-TS

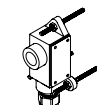

TM120C-SM-HB

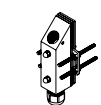

TM125-HB



TMR2

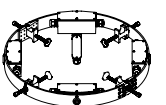

TS-SO

Extension:

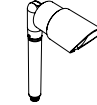

Fixture With EX-RD



EX-RD

Sign Light Arm: Please reference the Sign & Pole Mounting section in [Accessories](#) on our website.

 Readymade eligible configurations ship in 2 to 4 weeks.

Notes:



PHOTOMETRY & ENERGY DATA

ZXA16 (Very Narrow)

Input Power	11.5 W
Color Temperature (CCT)	3000K
Color Rendering Index (Ra)	90+
Beam Angle	14°
Max. Candlepower	6132cd
Delivered Lumens	450lm
Efficacy	39lm/W

Polar Graph - Intensity

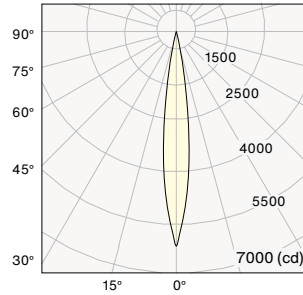

Cone of Light - Illuminance

Light Level (fc)	Beam Diameter	Mtg Height
1533.11	0.48'	2.0'
383.28	0.95'	4.0'
170.35	1.43'	6.0'
95.82	1.90'	8.0'
61.32	2.38'	10.0'

1/2 Beam Angle: 14°

ZXA16 (Medium)

Input Power	11.5 W
Color Temperature (CCT)	3000K
Color Rendering Index (Ra)	90+
Beam Angle	44°
Max. Candlepower	1467cd
Delivered Lumens	711lm
Efficacy	62lm/W

Polar Graph - Intensity

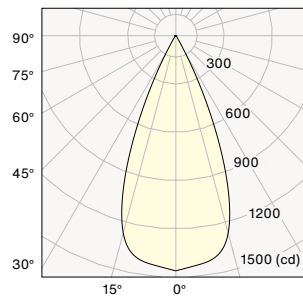

Cone of Light - Illuminance

Light Level (fc)	Beam Diameter	Mtg Height
366.67	1.60'	2.0'
91.67	3.21'	4.0'
40.74	4.81'	6.0'
22.92	6.42'	8.0'
14.67	8.02'	10.0'

1/2 Beam Angle: 44°

ZXA16 (Extra Wide)

Input Power	11.5 W
Color Temperature (CCT)	3000K
Color Rendering Index (Ra)	90+
Beam Angle	69°
Max. Candlepower	870cd
Delivered Lumens	943lm
Efficacy	82lm/W

Polar Graph - Intensity

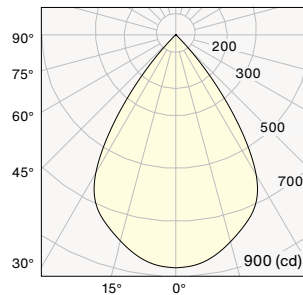

Cone of Light - Illuminance

Light Level (fc)	Beam Diameter	Mtg Height
217.57	2.74'	2.0'
54.39	5.48'	4.0'
24.17	8.22'	6.0'
13.60	10.96'	8.0'
8.70	13.70'	10.0'

1/2 Beam Angle: 69°

WATTAGE MULTIPLIER

Wattage	Multiplier
5 Watt	0.53
7 Watt	0.83
10 Watt	1.00

CCT MULTIPLIER

Color Temp.	Multiplier
2700k	0.97
3000k	1.00
4000k	1.05